



**CATHERINE WAGNER** Wonderwall, Louisiana World Exposition, New Orleans, 1984

*Wagner's 4 x 5 negative provides precise rendering of small details in this crowded scene, even in a very big print. She chooses a view camera for the high resolution of large-format film and also for the camera's ability to control convergence. From this high vantage point, any other camera would render the numerous vertical lines at angles to each other instead of parallel (see pages 254–255).*



**MICHAEL GRECCO** Portrait of Arnold Newman, 1994

*The face of portrait photographer Arnold Newman appears upside down on the ground glass of a view camera. An upside-down image is what a photographer sees when focusing a view camera.*

**W**hy would a photographer use a bulky, heavy, slow-working view camera—a camera that has few or no automatic features, that has to be used with a tripod, that shows you an image upside down that is so dim that you need to put a dark cloth over the camera and your head to see it? The answer is that the view camera does some jobs so well that it is worth the trouble of using it.

**A view camera's movements give you an extraordinary amount of control over the image.** The camera's back (image plane or film plane) and front (lens plane) can be independently moved in any direction: up, down, or sideways, tilted forward or back, swiveled to either side. These movements can change the area of a

**A view camera's movements** give you the ability to control the position, focus, and shape of your subject as it appears in your photograph.

**Handling a view camera and developing sheet film** are not difficult, but are somewhat different from techniques used with other cameras.

**Inside a View Camera** .....242

**View Camera Movements** .....244

Rise and Fall ..... 244

Shift .....246

Tilt .....248

Swing.....250

**Using a View Camera to Control**

**the Image** .....252

Controlling the Plane of Focus .....253

Controlling Perspective.....254

**Equipment You'll Need**.....256

**What to Do First—and Next** .....257

**Loading and Processing Sheet Film** .....258

scene that will be recorded, select the most sharply focused plane, or alter the shape of the subject itself.

**The view camera's large format is also an advantage.** The most common size for view cameras is 4 x 5 inches, for which digital adapter backs are made. Other film sizes are also used: 5 x 7, 8 x 10, and sometimes larger. While modern small-camera films (1 x 1 1/2 inches is the size of 35mm film) and digital cameras can make excellent enlargements, the greatest image clarity and detail and the least grain are produced from a large-size negative or capture area. Because digital capture backs for view cameras are not in common use—and as expensive as a new car—this chapter refers only to film. The operating principles, however, are the same.

**A view camera's movements give it the ability to change and control an image.**

Unlike most cameras, which are permanently aligned so that lens and film stay exactly parallel, a view camera can be deliberately unaligned.

These movements and their effects, which are explained on the following pages, are easier to understand if you have a view camera at hand so you can demonstrate the effects for yourself.

**To make full use of a view camera's movements, you must use it with a lens of adequate covering power,** that is, a lens that produces a large image circle. As shown at right, a lens projects a circular image that decreases in sharpness and brightness at the edges. If a camera has a rigid body, the image circle needs to be just large enough to cover the size of the film being used. But a view camera lens must produce an image circle larger than the film size so that there is plenty of room within the image circle for various camera movements. If the movements are so great that the film intersects the edge of the image circle, the photograph will be vignetted—out of focus and dark in one or more corners. Covering power increases—the usable image circle gets slightly larger—as the lens is stopped down.

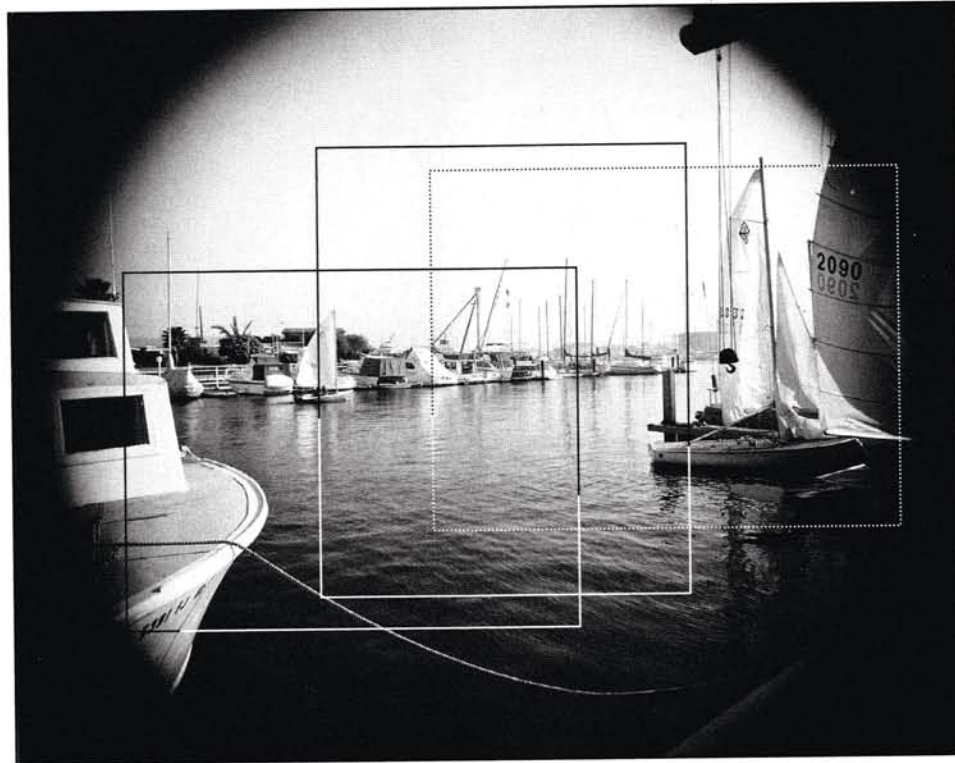

*A lens with good covering power (producing a large image circle) is necessary for a view camera. Camera movements such as rise, fall, or shift move the position of the film within the image circle (as shown above). But for you to be able to use these movements, your lens needs to produce an*

*image that is larger than the actual size of the film. Check the corners of the viewing screen before exposure to make sure the camera movements have not placed the film outside the image circle, vignetting the picture (dotted lines).*

## VIEW CAMERA MOVEMENTS

**Side View**

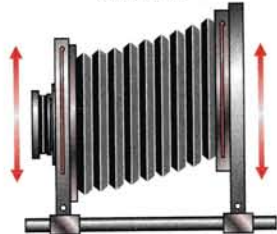

**Rise and fall** move the front or back of the camera in a flat plane, like opening or closing an ordinary window. Rise moves the front or back up; fall moves the front or back down.

**Top View**

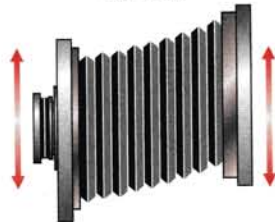

**Shift (like rise and fall)** also moves the front or back of the camera in a flat plane, but from side to side in a motion like moving a sliding door.

**Side View**



**Tilt** tips the front or back of the camera forward or backward around a horizontal axis. Nodding your head yes is a tilt of your face.

**Top View**



**Swing** twists the front or back of the camera around a vertical axis to the left or right. Shaking your head no is a swing of your face.

**This simplified view camera shows its basic relationship to all cameras: It is a box with a lens at one end and a sheet of film at the other. Unlike other cameras, however, the shape of the box can be changed.**

**Lens board**, which holds the lens, can be moved independently up or down, forward or back, from side to side, or at an angle.

**Bellows** expand or contract so that the lens board and camera back can be moved together or farther apart.

**Ground-glass** viewing screen shows the image.

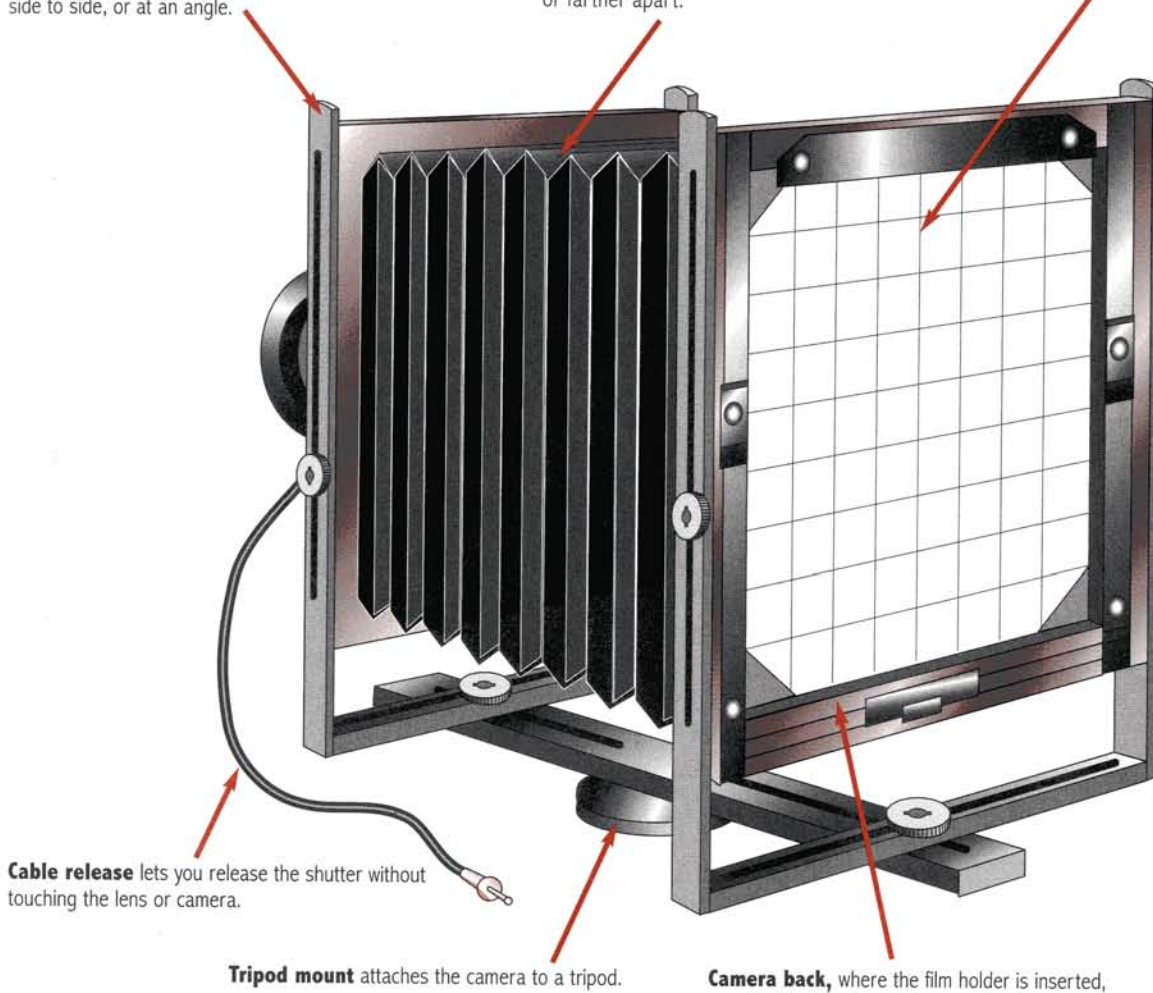

**Cable release** lets you release the shutter without touching the lens or camera.

**Tripod mount** attaches the camera to a tripod.

**Camera back**, where the film holder is inserted, can (like the lens board) be moved independently up or down, forward or back, from side to side, or at an angle. It can be rotated to take a picture in either a horizontal or vertical format.

**Film holder** holds individual pieces of sheet film. This style holds two sheets of film. A dark slide protects the film from light except when an exposure is made. The top of the dark slide is color coded: white side out for unexposed film, black side out for exposed film or an empty holder.



## View Camera Movements

### Rise and Fall

**Rise, an upward movement, and fall, a downward movement, change the placement of the image on the film** by changing the position of film and lens relative to each other. Moving the back moves the film to include various parts of the image circle. Moving the front moves the image circle so that a different part of it falls on the film.

**Rise or fall of the back does not affect the shape of the subject.** The effect is not unlike cropping a photograph during printing—the amount of the object shown or its position within the frame may change but not the shape of the object itself.

**Rise or fall of the front changes the point of view and to some extent the shape.** In the pictures opposite, the change in shape is too slight to be seen in the cube, but the difference in point of view is visible in the change of relationship between the cube and the small post.

**Why not just raise or lower the camera?** That is a good solution, when you can do so, but rise and fall give you an extra edge of control when your tripod can't raise or lower any more. In addition, moving the camera, like front rise and fall, changes the visual relation of objects (see last two illustrations, opposite). Back rise and fall give you the option of moving the image within the frame without changing the position of objects relative to each other.

**EZRA STOLLER** Kitt Peak Solar Observatory, Pima County, Arizona, 1970

*Architectural photographers use rise and fall to keep the lines of a building straight. In this scene, for example, if you wanted to see more at the top or bottom of the structure, you could just tilt the camera and tripod up or down, but that would make vertical lines in the image converge (see page 254). The solution is to keep the camera level, and use the camera's rise or fall movements, which make more visible at the top or bottom, but don't distort the shape of the building at the same time.*

*Ezra Stoller photographed buildings by Frank Lloyd Wright, Eero Saarinen, and many other architects. "Photography is space, light, texture, of course," Stoller once said, "but the really important element is time. That nanosecond when the image organizes itself on the ground glass."*

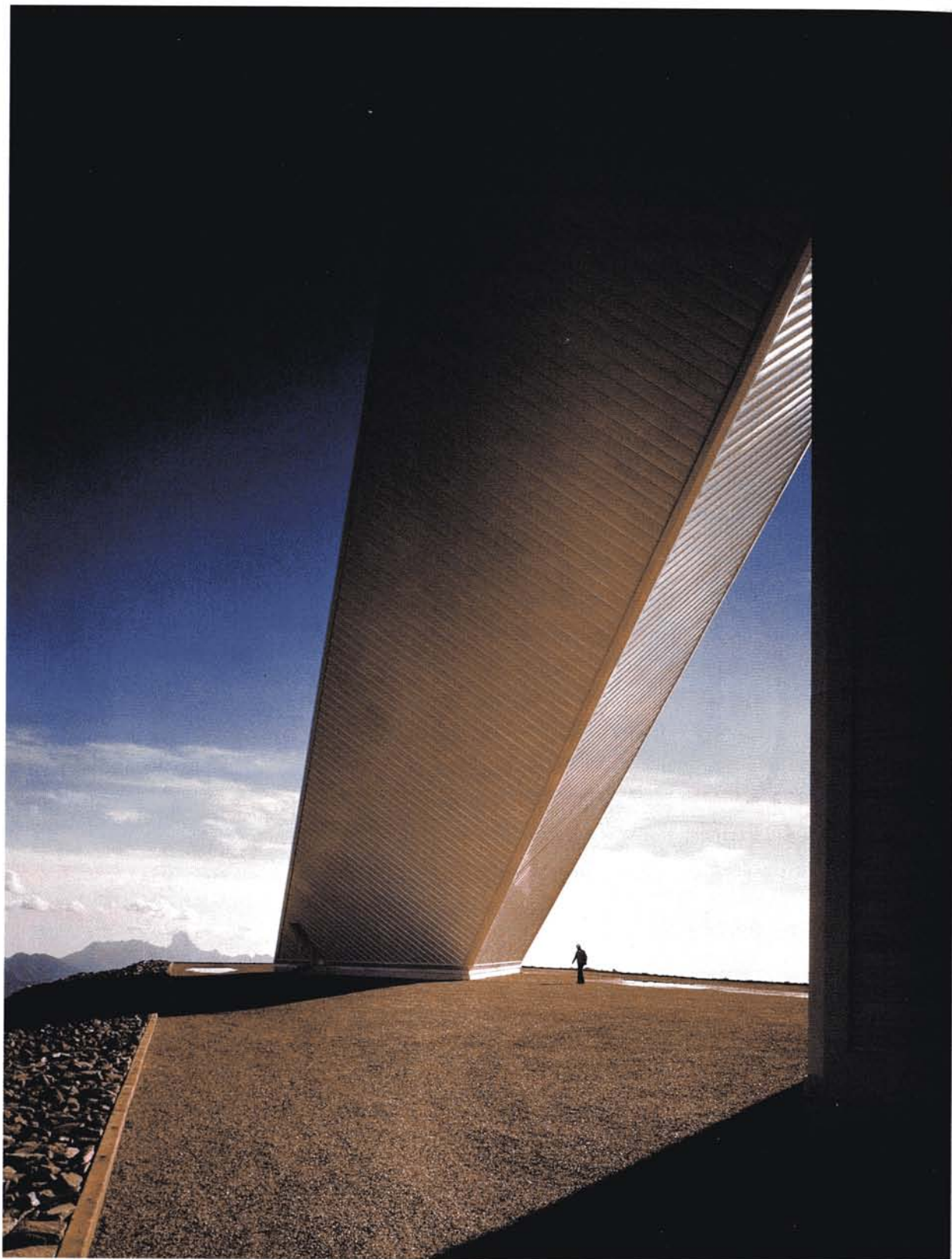

## RISE AND FALL ARE UP OR DOWN MOVEMENTS

Rise or fall of the front or back changes the position of the image in the frame. Rise or fall of the front moves the lens and so affects the relative position of foreground and background objects.

Compare the photograph of the reference cube (below), which was made with no movements set into the camera, to the photographs that follow to see the changes in shape, sharpness, and position that take place as a result of camera movements.

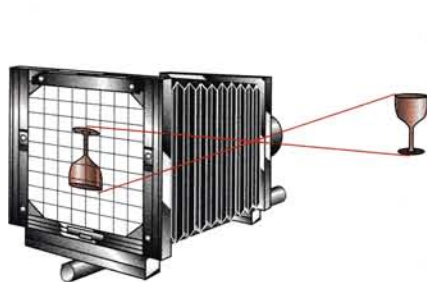

**Controls zeroed.** The object being photographed appears in the center of the ground-glass viewing screen. It is inverted (upside down and reversed left to right). The camera back and front are centered.

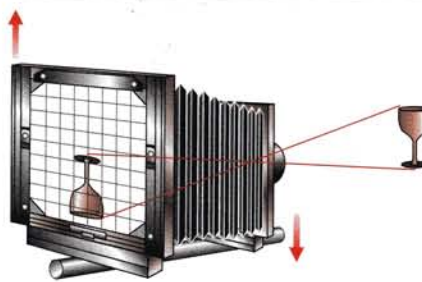

**Back rise or front fall.** The object has been moved to the bottom of the viewing screen (the top of the picture when viewed right side up). This is done by either raising the back or lowering the front (lens board).

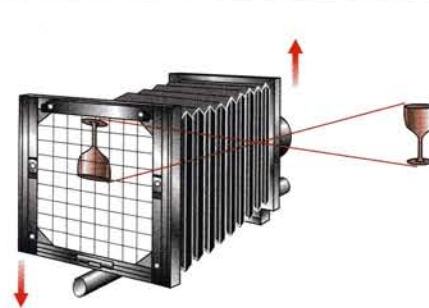

**Back fall or front rise.** To move the object to the top of the viewing screen (the bottom of the actual picture), lower the back or raise the front.

Final prints are shown below. The image on the camera's viewing screen would be upside down, as in the diagrams above.

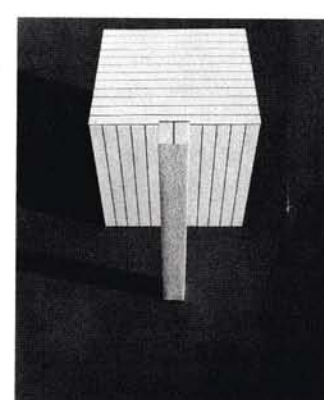
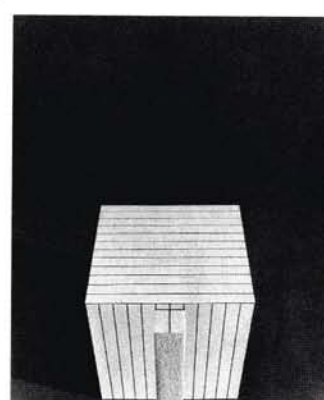
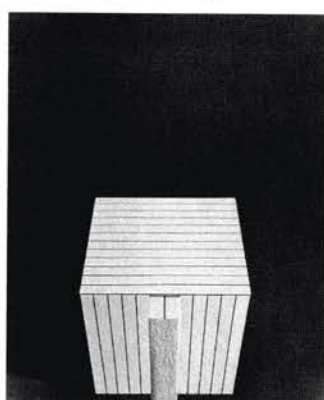
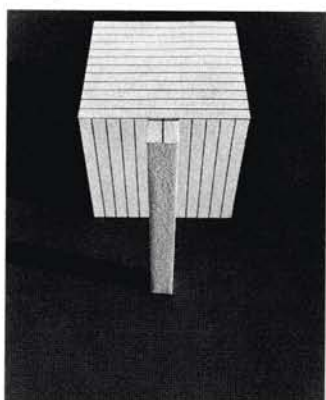

**Reference cube—all controls zeroed (in neutral position).** This photo was shot with all camera adjustments at zero, looking down from an angle of 45°. The cube was centered, with focus on the top front edge of the cube.

The image falls in the center of the picture frame. The cube's top front edge, being closest to the camera, is the largest. It is also the sharpest. The cube is symmetrical, with the two visible surfaces of the cube falling away in size and sharpness at an equal rate.

**Back rise, raising the back of the camera,** moves the cube higher on the film without changing its shape. If you compare this photograph with that of the reference cube, you'll see that this movement does not affect the position of the small post in front of the cube. The top of the post still lines up with the cube's front edge.

**Back fall, lowering the back of the camera,** lowers the position of the cube on the film. Like back rise, there is no change in the shape of the cube or its relation to the post. This is because the film, though raised or lowered, still gets the same image from the lens, which has not moved relative to the original alignment of cube and post.

**Front rise, raising the lens,** lowers the image of the cube on the film, just as back fall does. However, moving the lens causes a change that does not occur with back movement: it changes the relation between cube and post because the lens is now looking at them from a slightly different position. The farther apart that near and far objects are, the more this will be evident. Compare the apparent height of the post here with its height in the pictures at left; the post has dropped slightly below the edge of the cube.

**Front fall, lowering the lens,** raises the image on the film. Because the lens has moved, it also affects the relation of cube and post. Now the post appears to have moved slightly above the front edge of the cube.

## Shift

**Shift, a sideways movement, is the same as rise and fall except the movement takes place from side to side.** If you were to lay the camera on its side and raise or lower the back, you would produce the same effect as back shift. One way in which rise and fall are the same as shift is that neither changes the angle between the planes of film, lens, and subject. Raise, lower, or shift the back of the camera, and the film is still squarely facing the lens; the only difference is that a different part of the film is now directly behind the lens.

**Since shift is simply a sideways version of rise and fall, the results are similar.** Back movement to the left moves the subject to the left; back movement to the right moves it to the right. Left or right lens movements have just the opposite results.

**Spatial relationships change with front shift but not with back shift,** because the lens now views objects from a different point. Lens shift has the same effect on the point of view as moving the entire camera to the left or right. Back shift simply moves the entire image within the frame. The examples at right illustrate these movements, with the reference cube included for comparison.

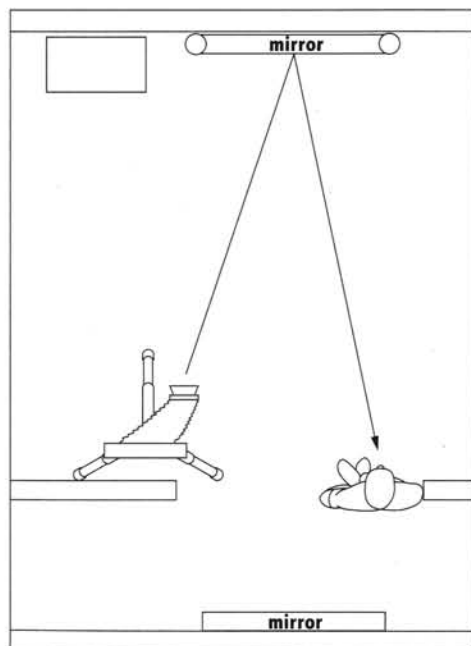

**KURT EDWARD FISHBACK** Roy DeCarava, 1982

*Shift can be used to get your camera out of the picture. Kurt Edward Fishback wanted the multiple reflections of photographer Roy DeCarava in his portrait, but he was also getting reflections of his own camera and tripod. He couldn't move any farther to the left, which would have removed from*

*the image not only the equipment, but one of the reflections of DeCarava as well. Instead, he used the shift movement on his view camera, which helped get himself out of the picture while keeping all the reflections of DeCarava.*

## SHIFT IS A SIDWAYS MOVEMENT

Shift of the front or back changes the position of the image in the frame. Shift of the front moves the lens, and so affects the relative position of foreground and background objects.

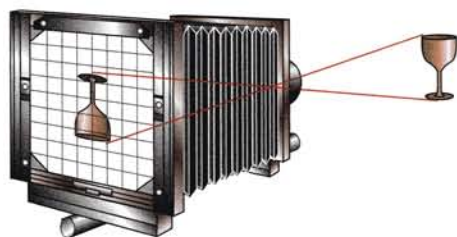

**Controls zeroed.** The image is in the center of the viewing screen.

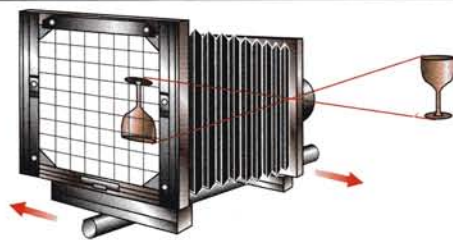

**Back shift left or front shift right.** The object has been moved to the right side of the viewing screen (left side of the actual photograph) by moving the camera back to the left or the front to the right.

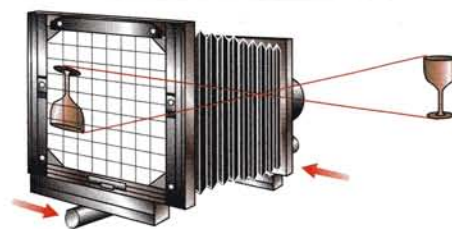

**Back shift right or front shift left.** To move the object to the other side of the picture, move the back to the right or the front to the left.

Final prints are shown below. The image on the camera's viewing screen would be upside down, as in the diagrams above.

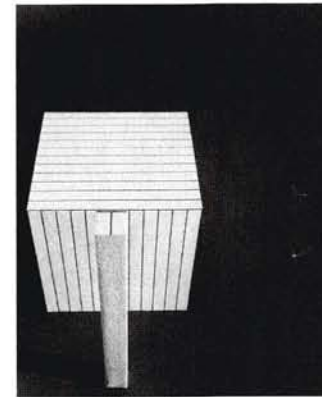
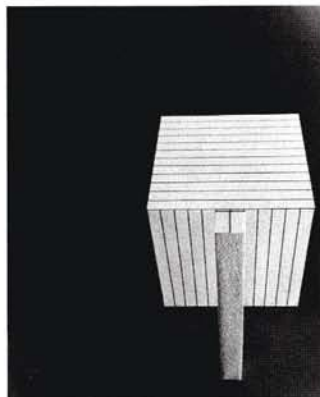

Top view



**Reference cube—all controls zeroed.** Shift, like rise and fall, has little perceptible effect on the shape of an object. Compare the reference cube with the four cubes to the right of it. While the cubes move back and forth on the film, they continue to look very much the same.

**Back shift left, moving the back to the left,** moves the cube to the left on the film. A camera equipped with a back that can move the film from side to side, as well as up and down, can place an object wherever desired on a sheet of film.

**Back shift right, moving the back to the right,** moves the image to the right. Comparison of this picture with the previous one shows no change in the shape of either the cube or the post in front of it. Their spatial relationship has remained unchanged also, despite the movement of the image on the film.

**Front shift left, moving the lens to the left,** moves the image on the film to the right. It also changes the relationship of post to cube. Since the lens actually moves to the left, it views the two objects from a slightly different position. One object appears to have moved slightly with respect to the other. The farther apart near and far objects are, the more a change is seen. Compare the position of the post against the vertical lines on the cube in this picture and the next.

**Front shift right, moving the lens to the right,** moves the image to the left and changes the relationships in space between objects. To summarize: If you want to move the image on the film but otherwise change nothing, raise, lower, or shift the back. If you want to move the image and also change the spatial relationship of objects, raise, lower, or shift the lens.



**Tilt, a forward or backward angled movement, can change both the shape and the focus of the image on the film.** The preceding pages show that rise, fall, and shift have little or no effect on the shape of an object being photographed because they do not change the angular relationship of the planes of film, lens, and object. But what happens with tilt, an angling of either the camera front or camera back?

Any change of the angle between front and back relocates the plane of focus, changing the way the picture looks. But the overall appearance of the photograph also depends on whether you change that angle by tilting the front or back of the camera. Tilting the back of the camera changes the shape of the object and also changes the focus. Tilting the front of the camera only changes the focus without changing the shape of the object.

**Tilting the back changes the shape.** To understand why this happens, look again at the reference cube. The bottom of the film sheet is the same distance from the lens as the top of the film sheet. As a result, light rays coming from the lens to the top and the bottom of the film traveled the same distance, and the top back edge and the bottom front edge of the cube are the same size in the photograph. But change those distances by tilting the camera back, and the sizes change.

**The rule is: The farther the image travels inside the camera, the larger it gets.** Since images appear upside down on film, tilting the top of the camera back to the rear will make the bottom of an object appear bigger in the photograph; tilting the top of the camera back to the front will make the top of an object appear bigger.

**Tilting the front changes the focus.** A tilt of the camera front does not change distances inside the camera and thus does not affect image size or shape, but it does affect focus by altering the lens's relationship to the film plane. Set the shape first by adjusting the back, then locate the plane of focus by adjusting the front.



**KEITH CARTER** Temple of Love, Versailles, 1999

*Keith Carter uses a medium-format camera with a lens that can tilt like a view camera's front. Tilting the lens relocates the plane of focus so that it is at an angle to the film plane; in this photograph, it is almost horizontal. The center of this scene remains sharp while the upper and lower parts blur. Carter presents the world in a way our eyes can never see it.*

## TILT IS AN ANGLED FORWARD OR BACKWARD MOVEMENT

Tilt of the back affects the shape of an object, which helps to control convergence (the apparent angling of parallel lines toward each other in a photograph). Tilt of the front or back relocates the plane of focus, which helps you make the most effective use of depth of field.

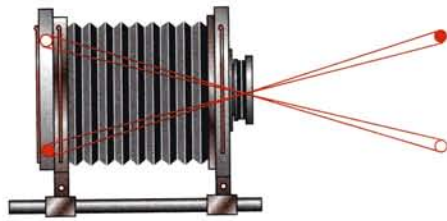

**Controls zeroed.** The images of two objects being photographed appear the same size on the viewing screen.

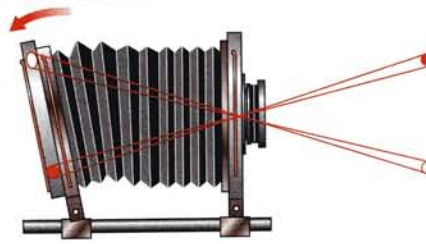

**Back tilt toward the back.** The image must travel farther from the lens to reach the top of the viewing screen than to reach the bottom. As light rays travel, they spread apart and increase the size of the image on the top of the screen (the bottom of the actual photograph) compared to the size of the image on the bottom of the screen.

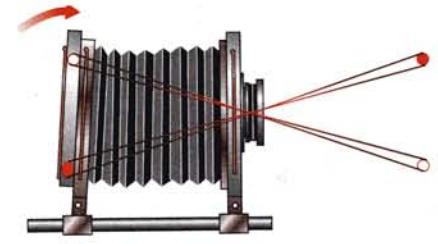

**Back tilt toward the front.** The size of the image on the bottom of the viewing screen increases compared to the size of the image on the top of the screen.

Final prints are shown below. The image on the camera's viewing screen would be upside down, as in the diagrams above.

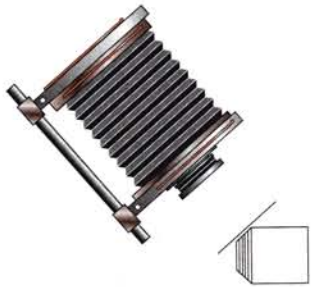
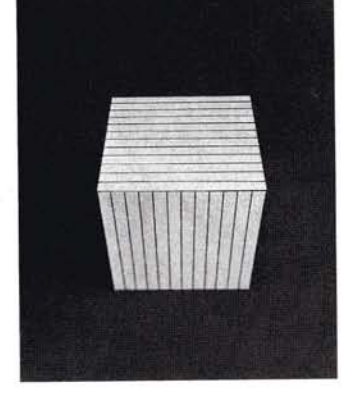
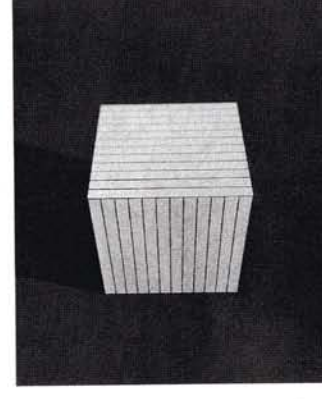
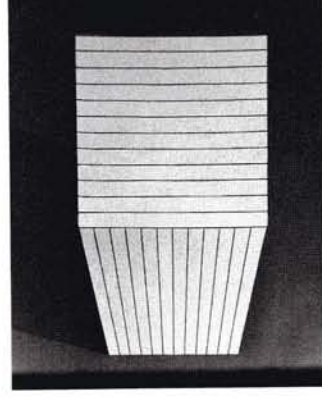
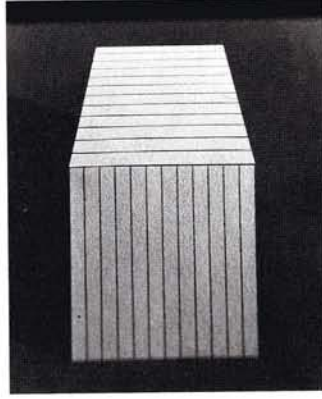
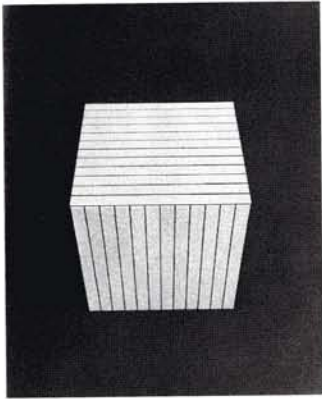

**Reference cube—all controls zeroed.** The 45° angle of view has produced an image that falls off in both size and sharpness at an equal rate on both the top and the front faces. As a result the two faces are exactly the same size and shape. Note also that the vertical lines on the front face, which are actually parallel on the cube, do not appear parallel in the photograph, but converge (come closer together) toward the bottom.

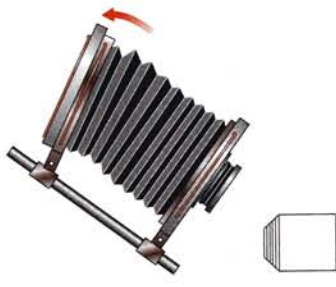

**Back tilt, moving the camera back toward the back.** The back of the camera is tilted so that the top of the film is farther away from the lens than in the reference shot. This movement enlarges the bottom of the cube, bringing its lines more nearly parallel. At the same time, this tilt has moved the bottom of the film closer to the lens than it was in the reference shot, shrinking the top back edge of the cube so that it converges more than before.



**Back tilt, moving the camera back toward the front.** If the back of the camera is tilted the other way, so that the top of the film is forward and the bottom is moved away from the lens, the top of the cube expands at the back and its sides become more parallel. The front bottom shrinks so its sides converge more. This movement results in some light loss on the part of the film moved farther from the lens. In this case the back edge of the top face is affected. In the picture at left the bottom edge of the front face is affected.

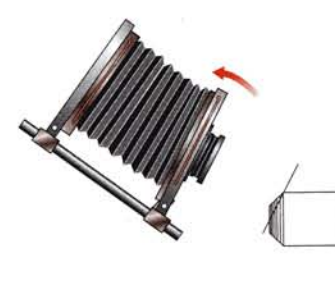

**Front tilt, moving the camera front toward the back.** When the lens is tilted, there is no change in the distance from lens to film; thus there is no change in the shape of the cube. However, there is a distinct change in focus. Here the lens has been tipped backward. This relocates the plane of focus to lay along the front face of the cube, pulling all of it into sharp focus. The top of the cube, however, is now more blurred than in the reference shot.

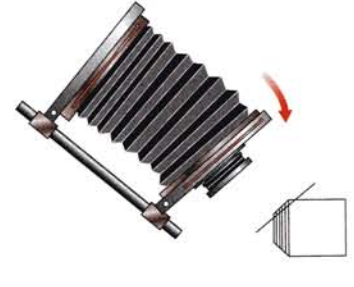

**Front tilt, moving the camera front toward the front.** If the lens is tilted forward, the top of the cube becomes sharp and the front more blurred. The focus control that lens tilt gives can be put to good use when combined with back tilt. Look again at the two back-tilt shots at the left; after tilting the back, the blurry side could have been made sharp by tilting the lens—although the other face would then be out of focus.

## Swing

**Swing, an angled left or right movement, can change the shape or focus of the image.** Like tilt, it has different effects depending on whether the front (lens plane) or back (image plane) is moved.

**Swinging the back of the camera changes the shape.** Like tilting the back, it moves one part of the film closer to the lens while moving another part farther away. This produces changes of shape in the image, reducing the size of one side (the image on the side of the back moved closer to the lens) while enlarging the other.

**Swinging the front of the camera changes the focus.** It swivels the lens to the left or right. As with tilt, any change in the angle between front and back (by moving either one) relocates the plane of focus. The general effect is to move the sharply defined zone of focus that is normally parallel to the film into a new position where it can cut at an angle across an object. Look at the two cubes, opposite page, far right. A narrow diagonal path of sharp focus travels across the top of each cube and runs down one side of the front.

**JOANN VERBURG** News from Paris, 1994

*Swinging the camera front to the left or right manipulates the plane of focus. In this photograph, an odd juxtaposition between the newspaper photo and the sculpture is enhanced by an angled plane of focus.*



## SWING IS AN ANGLED LEFT OR RIGHT MOVEMENT

Swing of the back affects the shape of an object, which helps to control convergence. Swing of the front relocates the plane of focus, which helps you make the most effective use of depth of field.

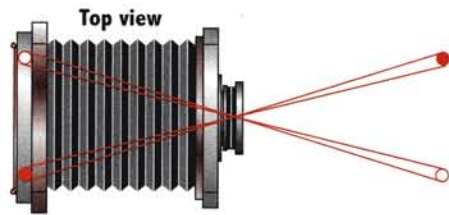

**Controls zeroed.** The images of two objects being photographed appear the same size on the viewing screen.

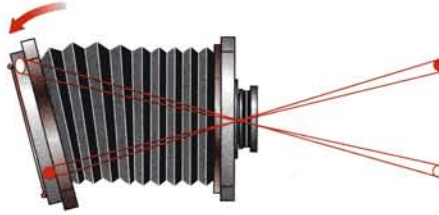

**Left swing of the camera back.** If one side of the camera back is swung away from the subject, part of the image will have to travel farther to reach the camera back and so will increase in size. Here the image on the left side of the viewing screen (the right side of the scene and of the photograph) has been increased in size by swinging the left side of the camera back away from the lens.

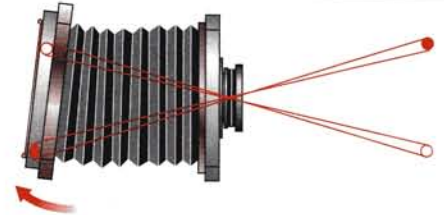

**Right swing of the camera back.** With the right side of the camera back swung away from the subject, the size of the image on the right side of the viewing screen (the left side of the scene and of the photograph) will increase in size.

Final prints are shown below. The image on the camera's viewing screen would be upside down, as in the diagrams above.

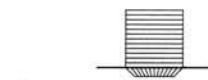
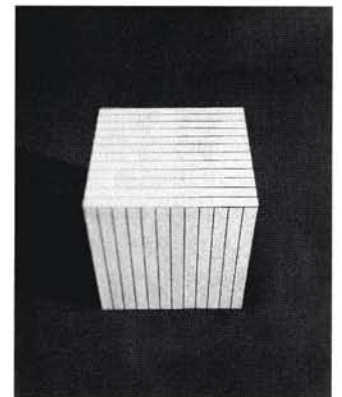
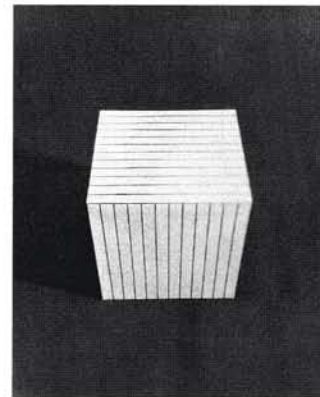
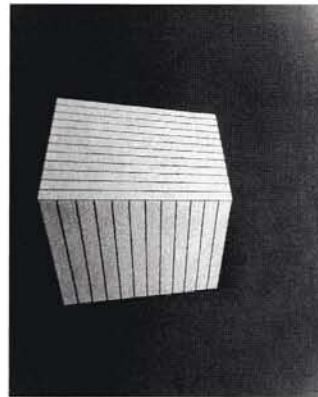
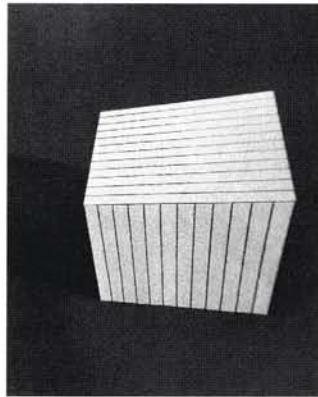

**Reference cube—all controls zeroed.** Comparing the reference cube to the pictures at right shows the effect on shape you can make by changing the angle of film to object. If you didn't understand the process by which such changes can be made, it would be hard to know that these swing shots—or the two back-tilt shots on page 249—are all of the same object, taken from the same spot with the same camera and lens.

**Left swing, moving the left side of the camera back toward the back.** This movement of the camera back swings the left side of the film away from the object and the right side closer to it, making the left side of the cube smaller and the right side larger. (Remember, the image is inverted on the ground glass.) This effect is the same as tilt, but sideways instead of backward or forward.

**Right swing, moving the right side of the camera back toward the back.** Here the right side of the film is swung away from the object and the left side closer to it. The results are the opposite of those in the previous picture. In both of them it can be seen that there is a falling off of sharpness on the "enlarged" edges of the cube. This is because swinging the back changed the angle between back and lens, relocating the plane of focus.

**Left swing, moving the left side of the camera front toward the back.** Since it is the lens that is being swung, and not the film, there is no change in the cube's shape. However, the position of the focal plane has been radically altered. In the reference picture it was parallel to the near edge of the cube, and that edge was sharp from one end to the other. Here the focus is a plane that skews through the cube, cutting diagonally across the top and down the left side of the cube's face.

**Right swing, moving the right side of the camera front toward the back.** Here is the same phenomenon as in the previous picture, except that the plane of sharp focus cuts the cube along its right side instead of its left. This selectivity of focus, particularly when tilt and swing of the lens are combined, can move the focal plane around very precisely to sharpen certain objects and throw others out of focus. For a good example of this, see page 253 bottom.

The practical applications of the view camera's ability to rise, fall, shift, tilt, and swing are virtually endless. You can control the plane of focus, which determines the parts of the scene that will be sharp. You can control the shape of an object by adjusting its horizontal or vertical perspective. You can control the placement of the scene within the image frame. The effects of these movements are summarized here and illustrated on the following pages.

## CONTROLLING THE PLANE OF FOCUS AND DEPTH OF FIELD



Suppose you need to get a horizontal surface in focus from the front of a subject to the back.



Tilt the front of the camera forward to align the plane of focus more with the top plane of the subject. Stop down the lens if you want also to increase the depth of field.

## CONTROLLING HORIZONTAL PERSPECTIVE WHEN SHOOTING AT A SIDE ANGLE TO THE SUBJECT

Top view



This technique is useful when the camera is pointing at a left-to-right angle to the subject, such as in architectural, product, or still-life photography.

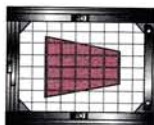

The subject looks like this on the ground glass, with converging horizontal lines.

Top view



Change the perspective by swinging the camera back (a) parallel to the face of the subject. Align the plane of focus with the object's parallel face by swinging the camera front (b) parallel to the camera back. Refocus, if needed.

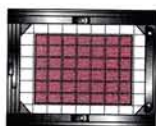

The perspective will be corrected so that horizontal lines will no longer converge.

## CONTROLLING VERTICAL PERSPECTIVE WHEN SHOOTING FROM A LOW CAMERA ANGLE



This technique is useful when the camera is pointing upward, such as when photographing buildings from a low angle.



The subject looks like this on the ground glass, with converging vertical lines. (Remember that the image is upside down on the ground glass.)



Change the perspective by tilting the camera back (a) parallel to the face of the subject. Change the focus by tilting the camera front (b) parallel to the camera back. Refocus, if needed.

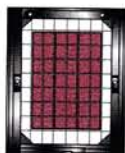

The perspective will be altered so that vertical lines will no longer converge.

## CONTROLLING VERTICAL PLACEMENT OF A SUBJECT IN THE IMAGE FRAME

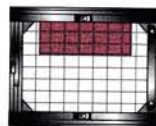

If the subject looks like this on the ground glass.

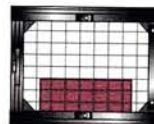

Or like this.



Move the subject image within the frame by using the front rise or fall or the back rise or fall.

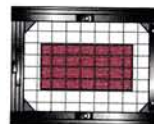

The placement of the subject within the frame will be changed. This technique can also be used to reduce reflections of the camera by not photographing the subject head on.

## CONTROLLING VERTICAL PERSPECTIVE WHEN SHOOTING FROM A HIGH CAMERA ANGLE



This technique is useful when the camera is pointing downward, which often happens in still life and product photography.

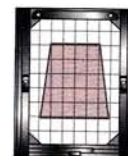

The subject looks (upside down) like this on the ground glass, with converging vertical lines.

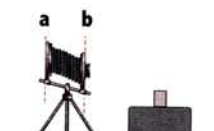

Change the perspective by tilting the camera back (a) parallel to the face of the subject. Change the focus by tilting the camera front (b) parallel to the camera back. Refocus, if needed.

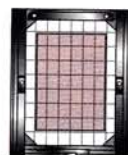

The perspective will be altered so that vertical lines will no longer converge.

## CONTROLLING HORIZONTAL PLACEMENT OF A SUBJECT IN THE IMAGE FRAME

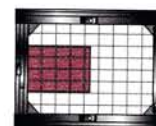

If the subject looks like this on the ground glass.

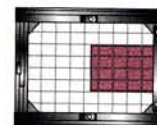

Or like this.



Move the image within the frame by shifting the front or back.

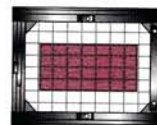

The placement of the subject within the frame will be changed. The technique can also be used to reduce or remove reflections.

## ADJUSTING THE PLANE OF FOCUS TO MAKE THE ENTIRE SCENE SHARP

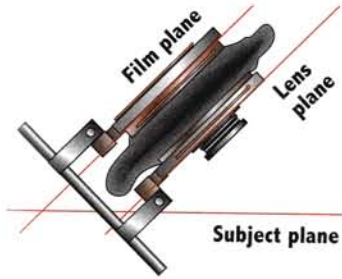

The book is partly out of focus because the lens plane and the film plane are not parallel to the subject plane. Instead of a regular accordion bellows, the diagrams show a bag bellows that can bring camera front and back closer together for use with a short focal-length lens.

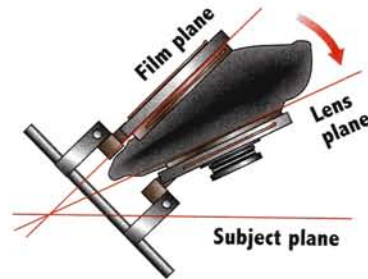

Tilting the front of the camera forward brings the entire page into sharp focus. The camera diagram illustrates the Scheimpflug principle, explained at right.

A view camera's movements let you control sharpness in an image, an advantage that becomes evident when photographing something that is not parallel to the film, like the rare book shown here. If you focus on the part of the book close to the camera, the top of the book, more distant, is blurred and vice versa. A compromise focus on the middle of the page might not give enough depth of field even if you stopped the lens all the way down.

With a view camera you can adjust the plane of focus. If you set your view camera like any other camera, with front and back parallel to each other, the plane of focus will always cut through the subject parallel to the film. With a view camera, you can make more of the book page sharp by adjusting the camera front to move the plane of focus until it coincides as exactly as possible with the surface of the book page. If the page is still not completely sharp, it is because the page is not completely flat; stop down the lens aperture to increase the depth of field.

**Scheimpflug makes it predictable.** If you want to know how to adjust a view camera so that a specific plane of the subject is in focus, the Scheimpflug principle tells you. This rule (named after its discoverer) says that if the camera's lens plane and film plane are not parallel, then the plane of focus will meet those two planes in a line. Fortunately, you don't have to calculate exactly where the three planes meet (you will be able to see on the ground glass when the image is sharp), but it does tell you which way to swing or tilt in order to relocate the plane of focus where you want it.

If you want only part of the picture to be sharp, this too is adjustable with a view camera. By swinging or tilting the camera front, the plane of focus can be angled across the picture, as in the photographs of the spilled beans, left, and the photographs on pages 248 and 250.

## ADJUSTING THE PLANE OF FOCUS TO MAKE ONLY PART OF THE SCENE SHARP

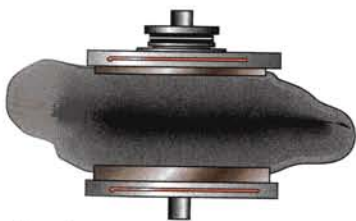

Top view

Here the photographer wanted just the spilled beans sharp, not those in the foreground and background jars.



A swing of the camera front to the right moves the plane of focus to angle along the receding pile of beans. The photographer opened up the lens to its maximum of  $f/5.6$ , which throws the other jars out of focus and directs attention to the beans.

**A view camera is often used in architectural photography for controlling perspective.** It is almost impossible to photograph a building without convergence unless a view camera is used. You don't have to make parallel lines in the subject appear parallel in the photograph, but a view camera provides the means if you want to do so.

**Photographing a building head on isn't always as simple as it seems.** Suppose you wanted to photograph the building at right with just one side or face showing. If you leveled the camera and pointed it straight at the building, you would show only the bottom of the building (photograph, near right).

Tilting up the camera shows the entire building but introduces a potentially undesirable perspective (photograph, far right): the vertical lines seem to come together or converge. This happens because the top of the building is farther away and so appears smaller than the bottom of the building. When you look up at any building, your eyes also see the same converging lines, but the brain compensates for the convergence and it passes unnoticed. In a photograph, however, it is immediately noticeable.

The view camera's cure for convergence is shown in the photograph opposite, left. The camera's back is adjusted to remain parallel to the building (eliminating the distortion), while still showing the building from bottom to top.

**Another problem arises if you want to photograph a building with two sides showing.** In the photograph opposite, center, the vertical lines appear correct but the horizontal lines converge. They make the near top corner of the building seem to jut up unnaturally sharp and high in a so-called ship's-prow effect. Swinging the back more nearly parallel to one of the sides (usually the wider one) reduces the horizontal convergence and with it the ship's prow (opposite, right).

### CONTROLLING CONVERGING LINES: THE KEYSTONE EFFECT

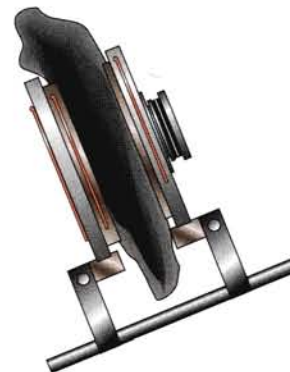
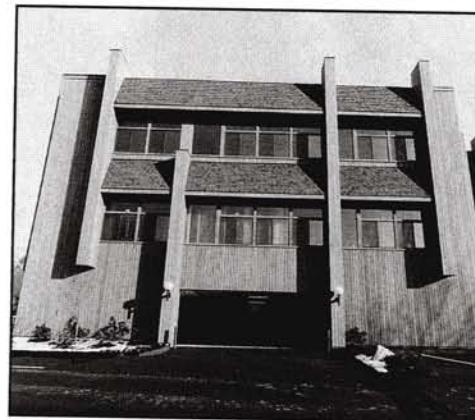

**Standing at street level and shooting straight at a building produces too much street and too little building.** Sometimes it is possible to move back far enough to show the entire building while keeping the camera level, but this adds even more foreground and usually something gets in the way.

**Tilting the whole camera up shows the entire building but distorts its shape.** Since the top is farther from the camera than the bottom, it appears smaller; the vertical lines of the building seem to be coming closer together, or converging, near the top. This is named the keystone effect, after the wedge-shaped stone at the top of an arch. This convergence gives the illusion that the building is falling backward—an effect particularly noticeable when only one side of the building is visible.

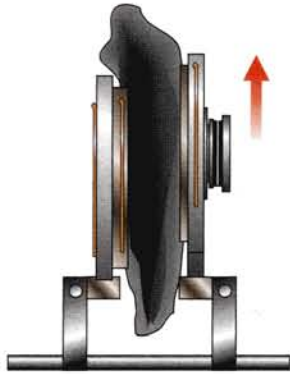
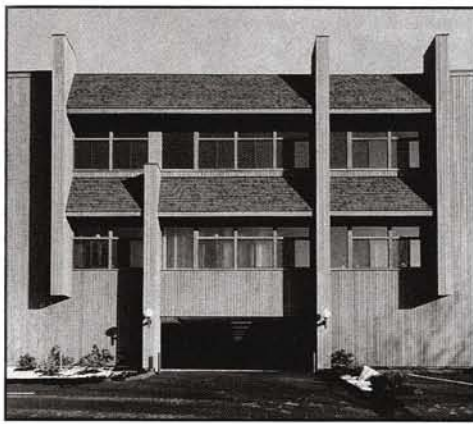

**To straighten up the converging vertical lines, keep the camera back parallel to the face of the building.** To keep the face of the building in focus, make sure the lens is parallel to the camera back. One way to do this is to level the camera and then use the rising front or falling back movements or both.

Another solution is to point the camera upward toward the top of the building, then use the tilting movements—first to tilt the back to a vertical position (which squares the shape of the building), then to tilt the lens so it is parallel to the camera back (which brings the face of the building into focus). The lens and film will end up in the same positions with both methods.

## CONTROLLING CONVERGING LINES: THE SHIP'S-PROW EFFECT

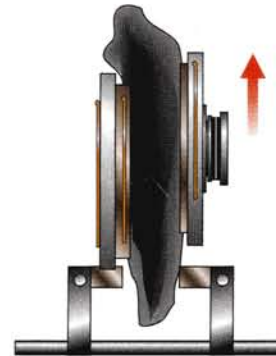

**Photographing at an angle to a building can also create distortion.** In this view showing two sides of a building, the camera has been adjusted as in the preceding picture. The vertical lines of the building do not converge, but the horizontal lines of the building's sides do, since they are still at an angle to the camera. This produces an exaggeratedly sharp angle, called the ship's-prow effect, at the top left front corner of the building.

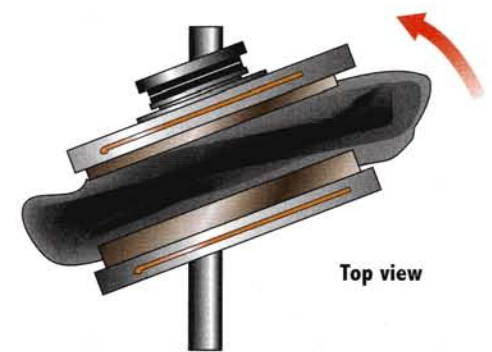
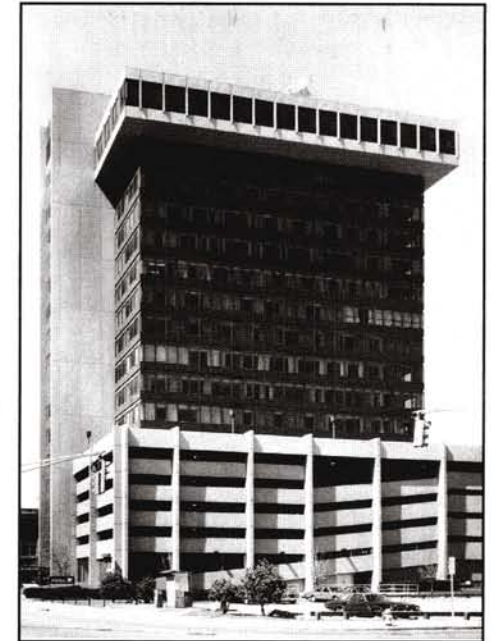

**To remove the ship's-prow effect, add two more movements.** Swing the camera back so it is parallel to one side of the building. Here the back is parallel to the wider side. Also, swing the lens so it is parallel to the camera back, which keeps the entire side of the building in focus. It is important to check the corners of the image for vignetting when you use camera movements.



## CAMERA EQUIPMENT

You may already have some of the following equipment.



**4 x 5 view camera** is the most popular size. The term 4 x 5 ("four by five") describes the size of film the camera accepts—4 x 5 inches. Most camera bodies are made of metal. A few are made of wood, which is lighter to carry around, an advantage when working outdoors.

**Lens** is mounted in a lens board that slips into the camera's front standard (the frame that facilitates the lens movements). The lens should be suitable for large-format use, that is, produce an image circle large enough to allow for camera movements. For a 4 x 5 format, a normal focal length is 150mm, long focal length 210mm or longer, short focal length 105mm or shorter.



**Sheet film holders** for 4 x 5-inch film. Film is loaded before use into the reusable holder. Each holder accepts two sheets of film, one on each side. If you carry six holders, you will be able to make twelve exposures before you have to reload.

**4 x 5 film of your choice.** Like roll film, sheet film is made in black and white or color, in various film speeds, and for negatives or transparencies. Polaroid and Fuji make color and black-and-white self-developing films that are usable in special film holders.

Fuji and Kodak package some of their color and black-and-white sheet films in individual protective packets (called QuickLoad or Readyload) that can be handled in the light. For use, the packets slip into a matching film holder or one made for 4 x 5 self-developing film. After exposure you can take the packets directly to a lab for processing or you can open the packets and remove the film in your own darkroom.



**Tripod** is essential. Use a tripod sturdy enough for your camera, not a tiny one designed for 35mm use. For studio use, a camera stand on wheels makes it easy to move the camera around.

**Focusing cloth** covers your head and the ground glass. The cloth blocks extraneous light so you can see the relatively faint ground-glass image better.

**Focusing magnifier or loupe** lets you fine-tune focus.

**Handheld light meter** is needed for exposure calculations. Automatic exposure is not a view camera feature.

**Cable release** lets you release the shutter without touching the camera. It's possible to release the shutter without a cable release, but if you do you are likely to introduce camera movement and consequent blur.

**Carrying case** usually holds everything but your tripod. A case is a must for field work and is even convenient in a studio.

**Polaroid back** lets you expose and process instant films.

**Digital backs** attach to a traditional camera to let you make digital images.

**Bag (or wide-angle) bellows** (shown on page 253) is useful when the lens board must be brought very close to the camera back, such as with a very short-focal-length lens. The standard accordion-type bellow becomes rigid when compressed, and allows no movements.

**Bellows extensions and rail extensions** let you move the lens board farther than normal from the camera back, for close-up work or to use a very long-focal-length lens.

**Changing bag** lets you reload your film holders when you are in the field or when a darkroom is not available.

## EQUIPMENT & CHEMICALS FOR PROCESSING SHEET FILM

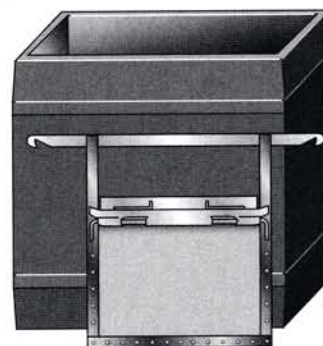

**Sheet film hangers** hold individual sheets of film for processing.

**Processing tanks** hold enough chemicals to process a number of sheets of film at a time.

**Developing trays** (such as you use for processing printing paper) can be used instead of hangers and tanks if you have only a few sheets of film to process.

**Film processing chemicals** are the same ones used in processing roll film.

**Film washers** hold film in hangers for a running water wash.

## MAKING AN EXPOSURE, STEP-BY-STEP

Because a view camera is so adjustable, its use requires the photographer to make many decisions. A beginner can easily get an I-don't-know-what-to-do-next feeling. So here are some suggestions.

**1 Set up the camera with the controls in zero position.** Set the camera on a sturdy tripod, attach a cable release to the shutter mechanism, point the camera toward the scene, zero the movements, and level the camera (right, top). Open the shutter for viewing and open the lens aperture to its widest setting. Use a focusing cloth to see the image clearly (center).

**2 Roughly frame and focus.** Adjust the back for a horizontal or vertical format and use the tripod head to roughly frame the image on the ground glass. Roughly focus by adjusting the distance between the camera front and camera back. The closer you are to the subject, the more you will need to increase the distance between front and back.

**3 Make more precise adjustments.** To change the shape or perspective of the objects in the scene, tilt or swing the camera back. You may also want to move the position of the image on the film by adjusting the tripod or using the rise, fall, or shift movements. Check the focus again (bottom). If necessary, reposition the plane of focus by tilting or swinging the lens. You can preview the depth of field by stopping down the lens diaphragm to the aperture you intend to use to make an exposure.

**4 Make final adjustments.** When the image is the way you want it, tighten all the controls. Check the corners of the viewing screen for possible vignetting. You may need to decrease some of the camera movements (especially lens movements) to eliminate vignetting.

**5 Make an exposure.** Close the shutter, adjust the aperture and shutter speed, and cock the shutter. Insert a loaded film holder until it reaches the stop flange that positions it. Remove the holder's dark slide to uncover a sheet of film that faces the lens, make sure the camera is steady, and release the shutter. Replace the dark slide so the all-black side faces out. Your exposure is now complete. Remove the film holder.

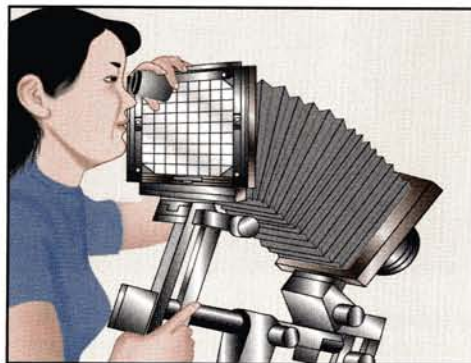
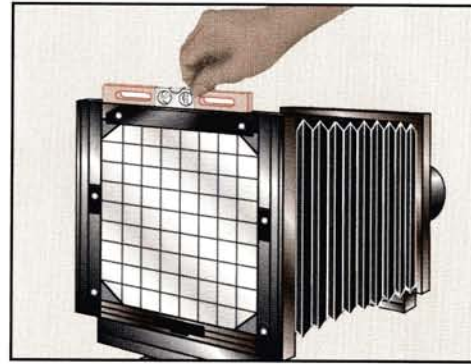

**Leveling the camera.** Zero the movements (sometimes called putting them in normal position) and level the camera before making any other adjustments. Zeroing is important because even a slight tilt or swing of the lens or back, for example, can distinctly change the focus. A spirit level, like a carpenter uses, levels the camera. Many cameras come with built-in spirit levels. Vertical leveling is important if you want the camera to be parallel to a vertical plane such as a building face. Horizontal leveling (left) is vital; without it the picture may seem off balance even if there are no horizontal lines in the scene.

**Using a focusing cloth.** The view camera's ground glass shows a relatively dim image, especially when you close down the lens to preview depth of field. A focusing cloth that covers the camera back and your head makes the image much more visible by keeping out stray light. You may not need the cloth if the subject is brightly lighted in an otherwise darkened room, but in most cases it is a necessity. Some photographers like a two-layer cloth—black on one side and white on the other—to reflect heat outdoors and to double as a fill-light reflector.

**Checking the focus.** A hand-held magnifier, or loupe, is useful for checking the focus on the ground glass. Check the depth of field by examining the focus with the lens stopped down. Examine the ground glass carefully for vignetting if camera movements (especially lens movements) are used. If the ground glass has cut corners, like the one shown here, you can check for vignetting by looking through one of the corners at the shape of the lens diaphragm. If there is no vignetting, the diaphragm will appear rounded—and not pointed—at its ends.

**Load film in total darkness into sheet-film holders that accept two sheets of film, one on each side.** Each sheet is protected by a light-tight dark slide that you remove after the holder is inserted in the camera for exposure. After exposure, but before you remove the holder from the camera, insert the holder's slide with the all-black side facing out. This is the only way to tell that the film below it has been exposed and to avoid an unintentional double exposure.

**The film must be loaded with the emulsion side out;** film loaded with the backing side out (facing toward the lens during exposure) will not produce a usable image. The emulsion side is determined by finding the code notches in one corner that identify the kind of film. When the film is in a horizontal position, the notches are in the lower right-hand (or upper left-hand) corner when the emulsion side of the film faces you.

**Developing sheet film follows the same basic procedure as developing roll film,** except for the way the film is held during development. Three tanks or trays are used—for developer, stop bath, and fixer. Add a fourth step, a water presoak before development, to tray development but not with tanks and hangers. The film is agitated and transferred from one solution to the next in total darkness. Fill tanks with enough solution to more than cover film in hangers. If you use trays, use at least one size larger than the film—5 x 7 trays for 4 x 5 film—and fill them deep enough for the number of sheets to be developed. One inch of liquid is probably a minimum.

Check the instructions carefully for the proper development time. The time will depend on whether you use intermittent agitation in a tank (usually stated as the time for “deep” tanks) or constant agitation in a tray.

### LOADING SHEET FILM



**Dusting holders.** It is a good idea to dust the film holders each time before loading them. This is usually less trouble than trying to retouch the spots on your image caused by dust on the unexposed film. A soft, wide paintbrush (used only for this purpose) or a negative brush works well; canned air or a bulb syringe also helps. Dust both sides of the dark slide, under the film guides, and around the bottom flap. Tapping the top of the holder can help dislodge dust inside the slot where the dark slides are inserted.

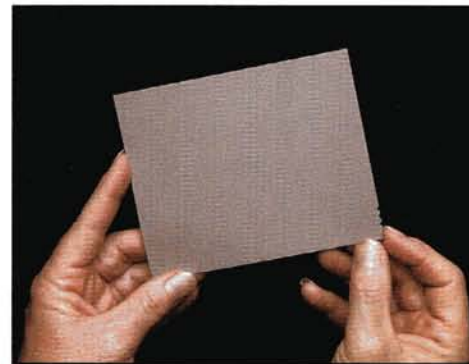

**Finding the notches.** Sheet film has notches on one edge—a different set for each type of film—so you can identify it and determine the emulsion side. The notches are always located so the emulsion side is facing you when the film is in a horizontal position and the notches are in the lower right-hand corner. Load the film with the holder in your left hand and the film in your right with your index finger resting on the notches. (If you are left-handed you may want to load with the holder in your right hand and the film in your left.) Touch only the edges.

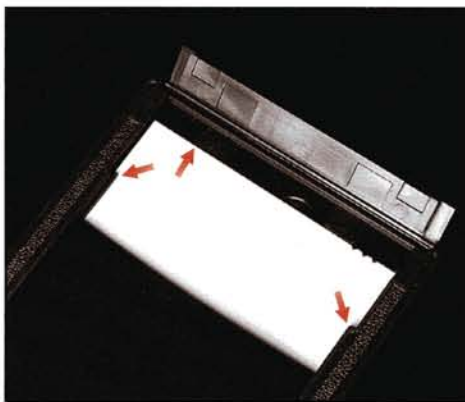

**Checking film insertion.** Open the bottom flap. Insert the film in the flap end of the holder underneath narrow guides. The guides for film are below the set of guides that the dark slide fits into. If you rest your fingers lightly on top of the guides you can feel even in the dark if the film is loading properly. Also make sure that the film is inserted all the way past the raised ridge at the flap end. When the film is in, hold the flap shut with one hand while you push the dark slide in with the other.



**Unexposed/exposed film.** The dark slide has two different sides—one all black, the other with a white (or, in older holders, bare metal) band at the top—so you can tell if the film in the holder is unexposed or exposed. When you load unexposed film, insert the slide with the white band facing out (top). After exposure, reinsert the slide with the black band facing out (bottom). The white band also has a series of raised dots or notches so you can identify it in the dark.

## PROCESSING SHEET FILM

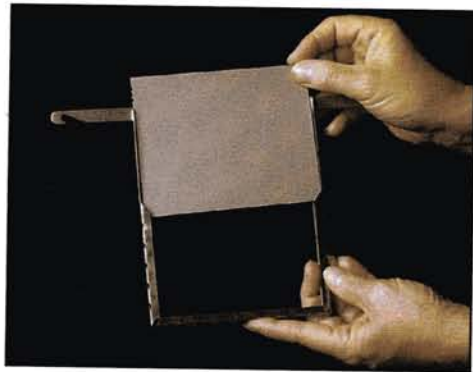

**Loading hangers.** Tank processing using film hangers is a convenient way to develop a number of sheets of film at one time. Load the hanger in the dark. First, spring open its top channel. Then slip the film down into the side channels until it fits into the bottom channel. Spring back the top channel, locking the film in place. Stack loaded hangers upright against the wall until all the film is ready for processing. Even better, use a clean, dry processing tank to collect the hangers as you load them. Handle them carefully.

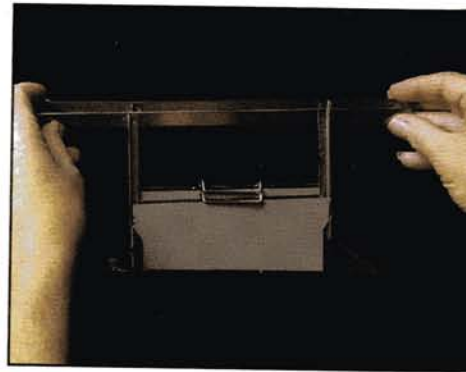

**Tank processing.** Hold the stack of loaded hangers in both hands with your forefingers under the protruding ends. Don't squeeze too many hangers into the tank; allow at least 1/2 inch of space between hangers. To start development, lower the stack—carefully but not slowly—into the developer. Tap the hangers sharply against the top of the tank to dislodge any air bubbles from the film. Make sure the hangers are separated. Immediately begin to agitate the film.

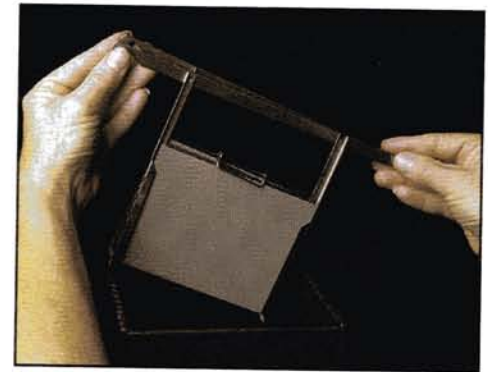

**Tank agitation.** Agitation for tank development takes place for the first minute, and 15 sec for each successive minute of development time. Lift the entire stack of hangers completely out of the developer. Tip it almost 90° to one side to drain the developer from the film. Replace it in the developer. Immediately lift the stack again and tilt almost 90° to drain to the opposite side. Replace in solution. These two operations together should take about 15 sec. Remove and replace hangers smoothly. Too-rapid motion will cause noticeable overdevelopment at edges.



**Tray processing.** If you have just a few sheets of film to develop, you can process them in trays. Fan the sheets so that they can be grasped quickly one at a time. Hold the film in one hand. With the other hand take a sheet and completely immerse it, emulsion side up, in the developer. Repeat until all sheets are immersed. (A water presoak before development is useful to prevent the sheets from sticking to each other.) If you are chemically sensitive, you may find tank development easier; individual sheets of film are not always easy to handle while wearing protective gloves.

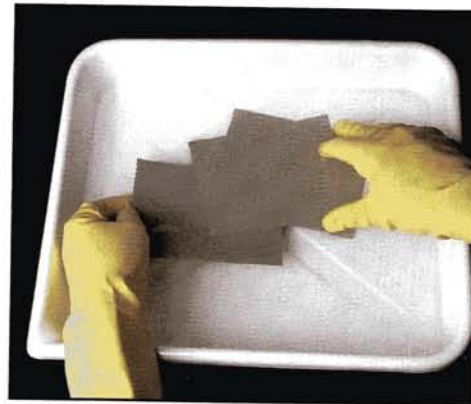

**Tray agitation.** All the film should be emulsion side up toward one corner of the tray. Slip out the bottom sheet of film and place it on top of the pile. Gently push it under the solution. Continue shuffling the pile of film a sheet at a time until the end of the development period. If you are developing only a single sheet of film, agitate by gently rocking the tray back and forth, then side to side. Be careful handling the film; the emulsion softens during development and scratches easily. As with roll film, complete the processing with stop bath, fixer, and a washing aid.



**Washing and drying.** Commercial film washers do the job best, but a few loose sheets of film at a time can be washed in a tray. Regulate the water flow carefully to avoid excessive swirling that could cause scratching. Film in hangers can be washed in a tank and then hung up to dry right in the hangers or sheets can be clipped to a line to dry as shown above. Separate the film enough so that the sheets do not accidentally stick together. A quick soak in a wetting agent such as Kodak Photo-Flo after washing will prevent water spots.